



GRAITEC
G ADVANCE

STARTING GUIDE

G GRAITEC

www.graitec.com

TABLE OF CONTENTS

INTRODUCTION	5
Advance Concrete	5
Where to find information?	6
Using the Online help	6
Using the context help	6
Contacting technical support	6
INSTALLATION	7
System requirements	7
Hardware	7
Software	7
Starting the installation	7
STARTING ADVANCE CONCRETE	8
ADVANCE CONCRETE USER INTERFACE	9
Other important tools for using Advance	10
3D MODEL	10
Accessing properties	11
Project settings	11
Creating a model	12
Creating walls	13
Using the UCS	14
Creating columns.....	15
Creating beams	16
Creating slabs.....	17
Creating openings	18
Opening libraries	18
Automatically creating a new level	20
Creating foundations	21
Creating a polygonal slab opening	22
Creating stairs	22

Drawing creation	24
Dimensions	25
Layouts	26
REINFORCEMENT	28
Reinforcement drawing	29
Creating the reinforcement	30
3D viewer	34
Placing the reinforcement symbols	35
Distribution dimensions	36
Lists	36

INTRODUCTION

This starting guide is a brief introduction to working with Advance Concrete, describing the basic Advance methodology and not meant to replace formal training.

The examples presented in this guide are generic for worldwide use and do not conform to local or specific company standards.

The **3D model** chapter describes the main Advance Concrete objects used to create a small building. The 3D model is created using a 1:1 scale. The model contains information about dimensions, objects, and attributes from which drawings are created as described in the **Drawing Creation** chapter. The **Layouts** chapter describes how to create layouts using the drawings created in the **Drawing Creation** chapter.

The **Reinforcement** chapter describes how the Advance Reinforcement module works.

Since not all Advance Concrete tools are described in this guide, refer to the *online Help* for more details on all commands and parameters.

Advance Concrete

Advance Concrete is a leading edge concrete construction application integrated into the latest AutoCAD® version under the Windows operating system. It provides a simple user-friendly working environment for creating 3D structural models from which drawings are created.

The three dimensional model is created using Advance Concrete intelligent objects and stored in a drawing (in DWG format). The Advance model forms the basis of the 3D construction.

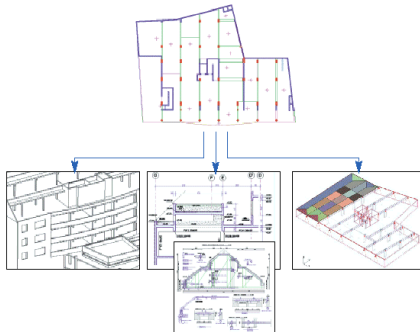

Once a model is complete, Advance Concrete creates all structural and reinforcement drawings using a large selection of view production tools, dimensions, locations, symbols, and automatic layout functions. Layouts are created from the created drawings.

*All software tools described in this guide and all remarks related to the product pertain only to the Advance Concrete suite and for reading simplification only the generic name **Advance** is used.*

Where to find information?

Using the Online help

Advance has an online help system that offers step-by-step instructions for every function.

To access the online help:

- Help toolbar: click 
- Advance Concrete menu: select Help > Online help
- Command line: grtchelp

Using the context help

Advance has context help that provides information on dialog box controls.

For assistance, click the [?] on the title bar and then click the control in the dialog box. An explanation tooltip is displayed.

Contacting technical support

GRAITEC offers a technical support center for assistance in the daily use of the software. To reach technical support:

- Ask your dealer or closest GRAITEC office for the appropriate telephone number.
- Or write to: support.advance.sc@graitec.com

INSTALLATION

To successfully install Advance certain requirements have to be met.

System requirements

Hardware

- PC with Pentium IV 1.5 GHz Processor (or better)
- Min. 1 GB (2GB recommended)
- AutoCAD® compatible graphics-card 128 MB or better
- Min. 512 MB free disk space on the hard disk
- Network adapter
- DVD Drive
- Mouse (3 buttons, with wheel recommended)

Software

- Operating system Windows XP Professional or Windows Vista.
- AutoCAD® 2004, ADT 2004, AutoCAD® 2005, ADT 2005, AutoCAD® 2006, ADT 2006, AutoCAD® 2007, ADT 2007, AutoCAD® 2008, AutoCAD® Architecture 2008, AutoCAD® 2009, AutoCAD® Architecture 2009.
- A MAPI compliant Microsoft mail system (Microsoft Outlook, Microsoft Outlook Express, etc.) used for sending requests for technical support through Advance Concrete.
- Microsoft Internet Explorer 4.0 or higher. This software is required for using the internet functions or the Online help.
- TCP/IP Protocol.
- The license file is delivered by email.

Refer to the *online Help* for further information.

Starting the installation

Close all active Windows applications before starting the installation.

Proceed with the installation as follows:

1. Insert the installation DVD in the DVD drive.
2. Start the installation by following one of these procedures:
 - On the Advance DVD – Browser, click **Setup**.or
 - From the Windows menu, select: **Start > Run**.
 - In the **Run** dialog box, click **Browse** to select the program *Setup.exe* on the DVD. Click **OK** to start.

The installation starts.

3. Select the language and click **OK** to continue.
4. Read the message and click **Next** to continue.
5. Read the license agreement. Check **I Agree**, and click **Next** to continue.
6. To change the default destination folder, click **Browse** and select the folder in which to install Advance.
To check the available space on each hard drive, click **Disk Cost**.
Select **Everyone** if Advance will be available for all users.
Select **Just me** if Advance will be available only for the current user.
Click **Next** to continue.
8. Click **Next** to start the installation.
9. Click **Close**. Restart the computer to complete the installation.

After installing Advance, the installation of a license is required to use the software. To authorize Advance software, follow the procedure described in the "*Installation guide*".

An authorization code is necessary to use Advance commands in AutoCAD®. Without the authorization code only the AutoCAD® commands will work. An authorization code is required for each workstation that uses Advance.

STARTING ADVANCE CONCRETE

To start AutoCAD® / Advance:

- Double click the **Advance Concrete** Icon on the desktop.

or

- On the Windows task bar, click **Start**, then select

Programs > Graitec > Advance Concrete and click the Advance icon to start the program.

ADVANCE CONCRETE USER INTERFACE

Advance Concrete is fully integrated into AutoCAD®. Customizable Advance Concrete toolbars are added to the list of available AutoCAD® toolbars.

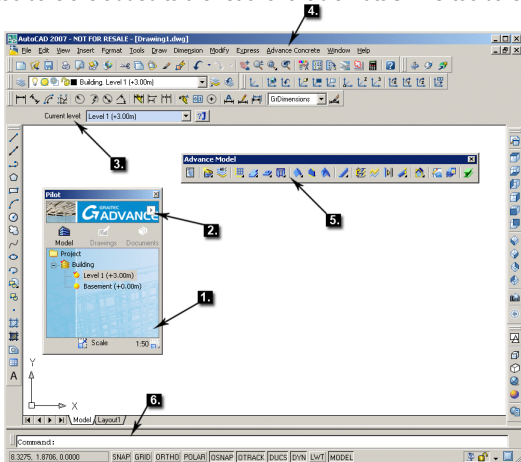

1. The Pilot

The Pilot is the starting point in the application. All different stages of the project creation are managed with the Pilot: model conception, general arrangement drawing creation, and layout creation. Click each of the three modes on the Pilot. Modes are switched from one to another without impacting the models or the drawings.

2. Fast access menu

The button in the upper Pilot area provides a menu for quick access to display controls and selection commands.

3. Smartbar

Each object (i.e., model elements, dimensions, symbols, etc.) has a properties bar called Smartbar for modifying the object attributes. The **Smartbar** is automatically activated in two instances:

When an object creation command is started, the Smartbar of that object appears. During the creation process, one or several object attributes can be modified.

When one or several objects of the same type are selected, one or several attributes can be modified. The modifications are confirmed by pressing **Enter**.

4. Advance Concrete menu

All the commands and tools are accessed using the Advance Concrete menu.

5. Toolbars

The main toolbars contain commands and buttons that open flyout toolbars. The flyout toolbar buttons are identified with a black triangle on the lower right corner. The flyout toolbars appear when the button is held down.

6. Command line

Advance commands can be entered using the keyboard. Press **Enter** after each entry.

Other important tools for using Advance

- To cancel a command in Advance , press the **Esc** key.
- The current command and prompts are displayed in the command line window at the bottom of the screen. Press the **F2** key to open and close the command window.
- When the cursor hovers over a toolbar button, the button's tooltip appears.
- The **Undo** command on the AutoCAD® **Standard** toolbar cancels one or several commands.
- The **Match properties** command on the AutoCAD® **Standard** toolbar copies properties from one object to another. The transferred properties are selected from the given list.

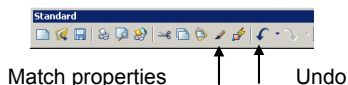

3D MODEL

Advance objects are created in 3D-space using the appropriate tools.

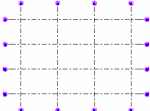
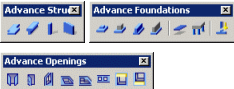
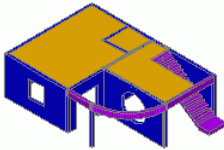
Advance Concrete objects	Example
Auxiliary objects: Grid 	
Structural elements: walls, beams, columns, slabs, footings, etc. 	

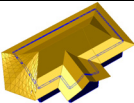
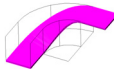
Advance Concrete objects	Example
Control surfaces: roofs and ramps 	 

Accessing properties

Every element has an associated detailed properties sheet on which data and attributes are modified.

To access the properties of an element:

- Smartbar: Click 
- Menu: Select Model > Element > Element properties
- Command line: type *grtcelproperties*

Project settings

Start Advance. Before drawing the model, some settings can be made:

- Project information: information to display in the title blocks
- Libraries: the model materials, geometries, doors, windows, piles
- Reinforcement libraries: available steel grades and sizes, bar length rounding, available bar shapes, concrete covers, etc.
- Representation styles pertaining to the modeling, the draft and the reinforcement elements
- Project preferences: options for drawing annotations, reinforcement numbering and display options, etc.

The project setting tools are grouped on the **Project settings** toolbar.



Example 1: Setting the project name

1. In the Pilot, right click **Project**.
2. From the context menu, select **Properties**. The project properties dialog box appears.
3. Enter "Project Example" for the project name.
4. Click **OK**.

Example 2: Setting the project working units

1. On the **Project settings** toolbar, click . The “Working Units Definition” dialog box appears.
2. Click lengths **Type** column and select **Centimeter** from the drop-down list.
3. Click **Apply**.

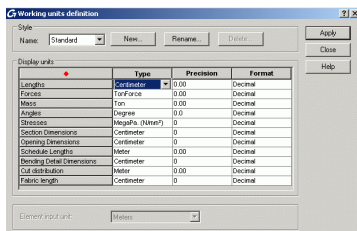

All the values entered on the Smartbar and all the length values for structural objects are now in centimeters.



In our project, the input values for the drawing length are in meters.

Creating a model

Advance provides all the specialized functions required for the creation of reinforced concrete structures: library of drag and drop structural elements (e.g., slabs, beams, columns, walls, foundations), openings (e.g., doors, windows, depressions, openings, niches), materials, and standard sections.

Before drawing the structural elements, set the default level height.

Example: Setting the building level height

1. In the Pilot, right click **Building**.
2. Select **Properties** from the context menu.
3. Set the default level height to **250 cm**.



The level height must be manually modified in the level properties; otherwise, it remains 300 cm.

4. Right click Level 1.
5. Set the level height to 250 cm.

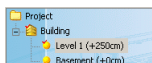

Creating walls

Advance provides a tool for creating several wall types:

- Straight walls: using two points
- Continuous walls
- Curved walls: using three circle points or two points and a center point.

Different kinds of walls are created using the “Properties” dialog box.



Example: Creating straight walls

1. On the **Model** toolbar, **Structural** flyout, click .
2. Press **F8** to activate the Ortho mode.
3. Click the graphic area to define a starting point and input the following values:

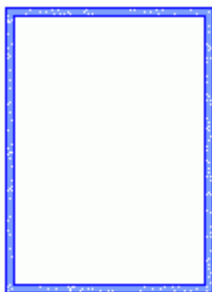



- Move the mouse cursor in the X-direction, enter **5** on the command line, and press **Enter** ↵
- Move the mouse cursor in the Y-direction, enter **3** and press **Enter** ↵
- Move the mouse cursor again in the Y-direction, enter **4** and press **Enter** ↵
- Move the mouse cursor in the -X-direction, enter **5** and press **Enter** ↵
- Move the mouse cursor in the -Y-direction, enter **7** and press **Enter** ↵

4. Press **Esc** to end.

Using the UCS

AutoUCS is an efficient and easy to use tool when working with relative coordinates in the creation and modification of structural elements. It can also be used as a measuring tool.

 **Example:** Using the UCS to create a wall

1. On the **Model** toolbar, **Structural** flyout, click .
2. On the **Tools** toolbar, click "Activate AutoUCS" .
3. Click the upper corner of the wall to place the AutoUCS origin.

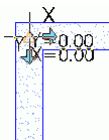

4. On the command line, enter the values 3,0 and press **Enter**. The start point of the wall is selected.

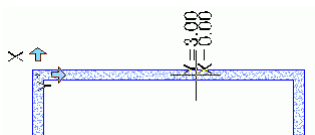

5. Move the mouse cursor in the -Y-direction, enter 2 and press **Enter**.

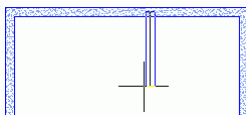

6. Move the mouse cursor in the X-direction, enter 2 and press **Enter**.

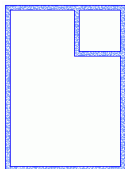



Creating columns

Using the Advance tools all types of columns are created:

- Straight columns
- Columns with slants according to a distance or an angle
- Columns with a tapered section
- Drop panel on the top of the columns

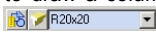
 **Example:** *Creating a straight column*

1. On the **Model** toolbar, **Structural** flyout, click .
2. On the Smartbar, enter **R20x20** to draw a column with a square-shaped section and 20 cm sides: .
3. On the Smartbar, select the central snap point from the drop-down list. .
4. Press **Enter**.
5. Position the first column at the bottom right corner.
6. Click to indicate the column orientation angle.

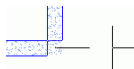

Draw as many columns as necessary using the same process.

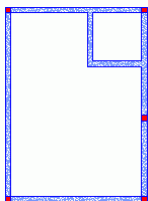

7. Press **Esc** to finish.



Copy

To copy an element to a new position click “Copy” on the AutoCAD® **Modify** flyout.



Example: Copying a straight wall

One of the previously created walls will be copied with all its properties.

1. On the AutoCAD® **Modify** toolbar, click .
2. Select the wall and press **Enter**.
3. Select the wall base point. .
4. Enter @5,3 on the command line to copy the wall.
5. Enter @5,7 on the command line.

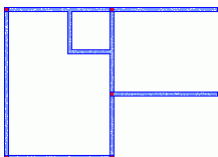

Example: Copying a column

Copy the column in the bottom-right corner 2m to the right using the AutoCAD® “Copy” tool.

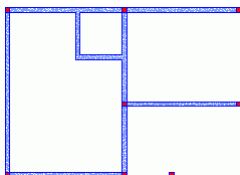

Creating beams

Advance provides a tool for creating straight and curved beams. During creation, the beam attributes are modified using the Smartbar. Various section types can be selected from the section library.

Example 1: Creating a straight beam

1. On the **Model** toolbar, **Structural** flyout, click .
2. Select the beam's starting point: the center of the column in the bottom-right corner.
3. Select the beam's second point: the center of the other column.

- Press **Enter** to end.



Example 2: Creating a curved beam

- On the **Model** toolbar, **Structural** flyout, click .
- Click the center of the first column.
- On the command line, type **CE** (Center) and press **Enter**.
- Specify the center on the horizontal wall.

*To select the curve center, press the **CTRL** key and right click. Select **Perpendicular** from the context menu.*

The beam is drawn in the trigonometric direction from the start point to the end one.

- Click the center of the second column.
- Press **Enter**.

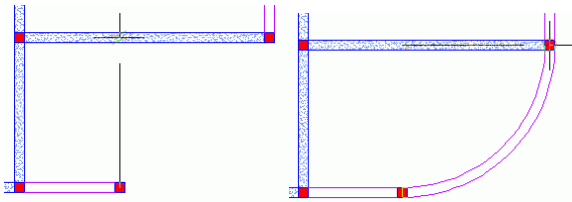

Creating slabs

Advance provides a tool that creates a slab in the current level. Slabs are created:

- By automatic detection
- Point by point

During the creation, the slab attributes are modified using the Smartbar. New slab points can be added using the AutoCAD® tools.

Example: Creating slabs by automatic detection

- On the **Model** toolbar, **Structural** flyout, click .
- On the command line, enter **D** (Detection) and press **Enter**.

- Click the four areas (as shown in the figure) to create the slabs.
- Press **Esc** to end.

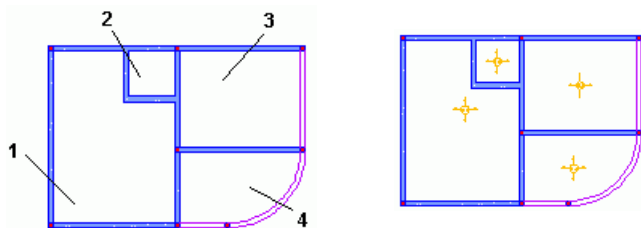

Creating openings

Advance provides commands for creating all kinds of openings (e.g., doors, windows, depressions, floor openings, and niches) and all kinds of holes shapes (e.g., rectangular, circular, and polygonal).

The Opening object depends entirely on the Wall object. Thus, when moving a wall, the opening is moved with it. If a wall is deleted, the opening linked to the wall is also deleted.

 **Example:** *Creating a window*

- On the **Model** toolbar, **Openings** flyout, click .
- Click the bottom wall.
- Place the window in the middle of the wall using the snap modes to objects.



Opening libraries

The doors and windows used in an Advance project can be modified or inserted from a library.

The library must first be imported into the model. The libraries can contain several doors and windows that are shared by different elements of the model.

Using and modifying the common library element decreases the memory space and improves Advance performance.

Example: Modifying a window

1. On the **Project settings** toolbar, click . The “Doors and windows library” dialog box appears.
2. Click the **Windows** tab.
3. Select the window type to modify.
4. Click **Properties**. The properties of the selected window are displayed on another panel of the window. The properties are read-only.
5. Click **Modify** .
6. In the table, modify the window opening size.
7. Click **OK**.

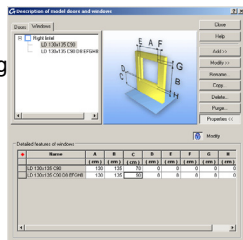
Example: Creating a door

1. On the **Openings** toolbar, click .
2. Click the wall.
3. On the Smartbar, select the door style (e.g., **LD 90x218 C7 J1**).
4. Click the middle of the wall to place the door.
5. Next, click inside the building to define the door opening direction.

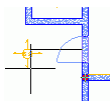
Example: Creating a circular wall opening

1. On the **Openings** toolbar, click .
2. Click the wall.
3. Click the middle of the wall to place the opening.

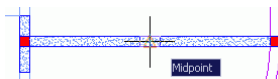

The opening is created. The properties can be modified.

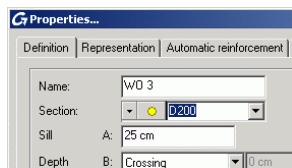

On the Smartbar, click

- Click the arrow and select the circular opening
- Enter the diameter: **200 cm**
- Enter **25 cm** for the sill.
- Close the dialog box.

Automatically creating a new level

Advance provides commands for copying an entire level as well as all its elements, which is useful when building levels are similar.



Copy level at top



Copy level below

Optionally, the created plan view can also be copied to avoid recreating all the visual elements for the level.

Example: Copying a level at top

1. In the Pilot, activate the first level.
2. On the **Levels** toolbar, click .
3. Type **N** (No) and press **Enter** to confirm.

The new level appears in the Pilot.

Double click **Building** in the Pilot. The two levels of the 3D building are displayed in 3D.

Shade/Cancel Shade

For a more realistic presentation of the model, click a **Shade** button on the AutoCAD® **Shade** toolbar (or Visual styles in AutoCAD® 2008).



To cancel the shading, click the **Wireframe** button on the AutoCAD® **Shade** toolbar (or Visual styles in AutoCAD® 2008).

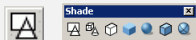

View angle

To change the view angle, use the buttons on the AutoCAD® **View** toolbar.

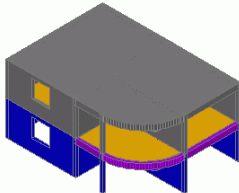

Creating foundations

Advance provides commands for creating isolated and continuous footings, beddings for isolated and continuous footings and piles, and a command for automatic foundation creation under the elements of the building's lowest level. The determination of the footing size depends only on the supporting geometry element.

 **Example:** *Automatically creating foundations*

1. On the **Model** toolbar, **Foundations** flyout, click .
2. Select the **Automatic determinations of footings** option.
3. Click **OK**.

The foundations are automatically placed under the first level of the building.

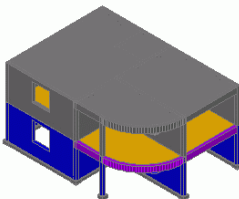

Plan view

To display the plan view, click the button on the AutoCAD® **View** toolbar.



Creating a polygonal slab opening

Before creating a stair, draw an opening in the third slab on the first level.

1. On the **Model** toolbar, **Openings** flyout, click .
2. Select the third slab.
3. Create the slab point by point, with the same procedure as for a polyline in AutoCAD®. For example, enter the following values:

Move the mouse cursor in the -Y-direction, enter **1.5** and press **Enter** ↵

Move the mouse cursor in the -X-direction, enter **3.75** and press **Enter** ↵

Move the mouse cursor in the Y-direction, enter **1.5** and press **Enter** ↵

Move the mouse cursor in the X-direction, enter **3.75** and press **Enter** ↵

4. Press **Enter** to finish.

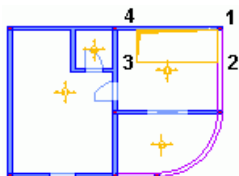

Creating stairs

Advance includes powerful tools for creating stairs. Features include:

- Stairs with one and two flights
- Intermediate step slab
- Rectangular stairs or trimmed by a contour

Several finishings for the top and bottom connections can be created.

Specific stairs are available on the main manufacturers web sites and can be added to the drawings or models.

 **Example:** *Creating a stair with one flight*

1. On the **Stairs** toolbar, click . The “Properties” dialog box opens.
2. In the **Properties** dialog box, set the stair parameters: the step number, the step height and width, etc.

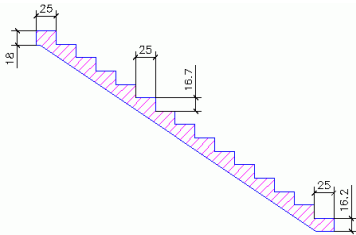

Step number: **14**

Height: **16.7 cm**

Width: **25 cm**

Height top step: **16.7 cm**

Height bottom step: **16.7 cm**

3. On the **Upper anchor** tab, use the **Next** and **Previous** buttons to select the desired top anchor stair.

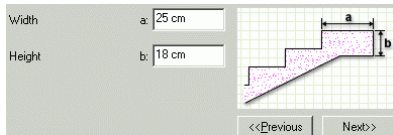

4. On the **Lower anchor** tab, use the **Next** and **Previous** buttons to select the desired bottom anchor stair.

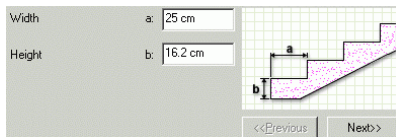

5. Click **OK**.
6. Place the stairs by clicking the two points defining the width.

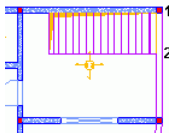

7. Press **Enter** to finish.



The stair upper level must be defined relative to the lower level.

8. Select the stair and double click it to access the stair properties.
9. On the **Definition** tab, select **In relation to lower level** in the "Upper level" drop-down list.
10. Enter **0 cm** in the **Value** field.

Drawing creation

Advance provides a large selection of view creation tools. Once the model is complete, the creation of the construction drawing can begin. Sections, elevations, isometric views, total or partial cuts can be automatically created.

The **Drawings** toolbar contains all the required tools for creating drawings and views.



Example 1: Creating a cut

1. On the **Drawings** toolbar, click
2. Draw the cutting plane. To define it, draw a vertical line across the building and press **Enter**.
3. Move the mouse to define the cut depth. Include the entire left part of the building.

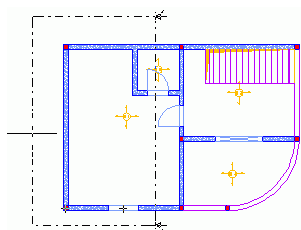

Next, calculate the cut:

4. In the Pilot, click to enter the Drawings mode. Section A-A appears. A red mark indicates that the view is not updated.



Double click **Section A-A** to calculate the section.

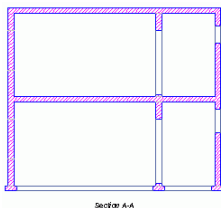

 **Example 2: Creating a plan view**

For every level, a corresponding plan view can be created. This association is automatically managed by Advance. The plan view is different from the level as it is just a model representation. All the necessary annotations, dimensions and other visual elements can be added. New entities cannot be created but the existing entities can be modified. Every modification made in the plan view affects the model.

1. In the Pilot, click **Model**  to enter the Model mode.
2. Double click **Building** to activate it.
3. On the **Drawings** toolbar, click .
4. In the "Select level" dialog box, click the first level.
5. Click **OK**.

The plan view is created.

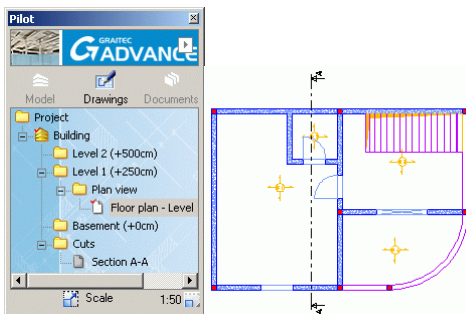

Dimensions

Advance provides tools for creating all dimensions types.

- Coordinate dimensions – displays the X and Y coordinates of the selected point.
- Level dimensions – places a symbol and an altitude on a number of points placed on a straight line. One of the points is considered as the altitudes origin and the associated altitude to this point can be changed. The other altitudes are calculated from the origin.
- Arc dimensions – dimensions the circle arc length or a curved object.
- Intersection dimension – takes into account the intersections with AutoCAD® standard graphic objects, model objects, as well as reinforcement elements and model contours.

- Associative dimension – automatically displays a certain number of preliminary defined dimensions for a given object. These dimensions apply to the object and its children (e.g., openings) and they can be entirely defined according the selected elements.
- Point by point dimension – creates a linear dimension starting from points.

The **Dimensions** toolbar contains all the necessary tools for creating dimensions.



Example: Creating an associative dimension

1. In the Pilot, double click **Floor plan - Level 1(+250cm)**. The plan view of the first level is displayed.
2. On the **Dimensions** toolbar, click .
3. Click the bottom wall.
4. Press **Enter**.
5. Click the drawing to position the dimension.

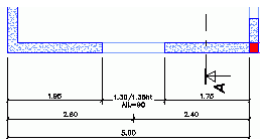

Layouts

Advance automatically creates layouts based on drawings. Title blocks and frames can be inserted in the layout.

Note: *Layouts are defined in the Documents mode.*

Example 1: Creating a layout with title block

A layout is created using the views created in the previous examples. The views are placed on the layout plan by dragging them from the Pilot.

1. In the Pilot, click **Documents**  to enter the Documents mode.
2. In the Pilot, right click the **Layout** folder and select **Create layout** from the context menu. The layout properties dialog box appears.

- Click **Modify** to add a title block or to modify the formatting.

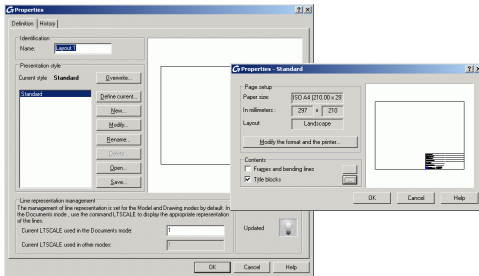

- In the properties dialog box, check **Title blocks**.
- Click .
- In the "Title block" dialog box, click **Add**.
- Browse and select a title block from the Advance folder tree (e.g., C:\Documents and Settings\All Users\Application Data\Graitec\AdvanceConcrete\2009\Support\Sample\Document\TitleBlock A4.a.dwg).

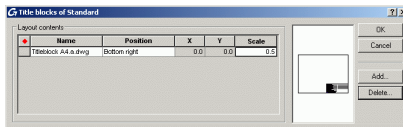

- Click **OK**.
- In the properties dialog box, click **OK**.

Example 2: Placing the drawings on the layout

- In the Pilot, click **Drawings**  to enter the Drawings mode.
- Select **Floor plan – Level 1 (+250cm)**.
- Press and hold down the left mouse button.
- Move the mouse and drag the view onto the layout. The scale can be modified on the Smartbar.



5. Release the mouse button and place the view on the layout.

Repeat the same procedure for the **Section A-A**.

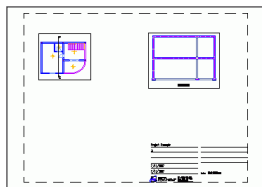

REINFORCEMENT

Advance provides a reinforcement module. Using the tools of this module reinforcement plans are drawn, reinforcement elements and distributions are created and material lists are generated.

The **Reinforcement** toolbar contains the necessary tools for reinforcement.



For certain structural objects, a reinforcement type is automatically assigned during object creation using the Automatic Reinforcement Wizard. These reinforcement styles are entirely customizable.

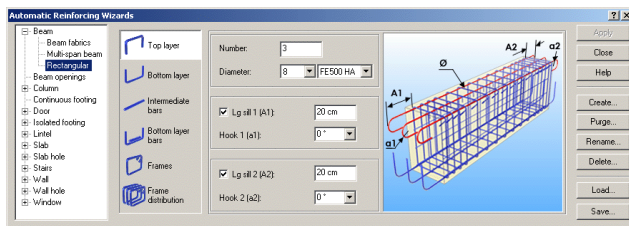

Reinforcement drawing

The basic plan for creating the reinforcement drawing is automatically created from a selected structural element. According to the selected view arrangement type, Advance creates the cuts and elevations.

 **Example:** *Creating the reinforcement drawing for a wall with a window opening*

Activate the second level of the building.

1. On the **Reinforcement** toolbar, click .

Note: *This command is accessible only in the Model mode.*

2. Select the bottom wall and press **Enter** to confirm. The first dialog box of the reinforcement view creation wizard appears.
3. On the right side of the dialog box select the arrangement of the views calculated by Advance: the number of views and the type of views. A graphic representation is displayed on the right side.
4. Click **Next**.
5. Click the viewport to modify. The picture changes accordingly. Next, the parameters can be modified on the right side of the window.

In the following steps, various parameters modify the edge styles for the visible and hidden objects, reinforcement representation styles, display of symbols, axes and symbol scale, and title parameters. Keep the default parameters and click **Next**.

6. By clicking **Finish**, the views are automatically created and the reinforcement drawing appears in the Pilot in Drawings mode.

Next the reinforcement can be drawn.

Creating the reinforcement

Next, the necessary bars are added on the drawing.

 **Example 1:** *Creating a rectangular bar on the window lintel cut*

1. On the **Reinforcement** toolbar, **Reinforcement bars** flyout, click .
2. Place the frame by clicking two points of the lintel diagonal.
3. Click a third point to position the hook of the rectangular frame.

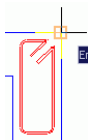

The frame is created.

 **Example 2:** *Creating a U bar*

1. On the **Reinforcement** toolbar, **Reinforcement bars** flyout, click .
2. Place a U bar by clicking two points of the U base.
3. Input the U direction in the wall and the desired U length value.

The U bar is created.

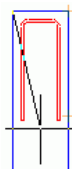

Similar, place a U bar on the window top view



Next, distributions are created around the window opening based on the three previously created bars.

 **Example3: Creating a linear distribution**

A distribution is created based on the rectangular frame.

1. On the **Reinforcement** toolbar, **Distributions** flyout, click .
2. Click the frame.

The Sideview tool automatically appears as two arrows. This tool sets the distribution bar direction.

3. Select the horizontal arrow to place this side of the rectangular frame on the wall elevation.

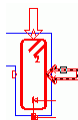

Zoom in on the window lintel on the wall elevation

4. Click the lower left corner of the lintel, and then the lower right corner.

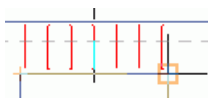

5. Next, click the lintel to specify the distribution bar direction.

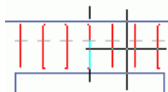

6. Using the gray rectangular frame, set the bar position in the distribution.

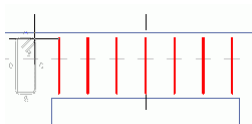

Similarly, place a U bar distribution on the window top view.

Create a distribution with the U bar on the window sill.

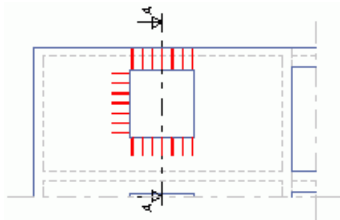

Example 4: Creating a straight bar

Zoom in on the window lintel on the wall elevation. First, the lower bar of the window lintel will be defined. Zoom in on the window lintel on the wall elevation.

1. On the **Reinforcement** toolbar, **Reinforcement bars** flyout, click .
2. On the **Smartbar**, select anchor for bar extremities 1 and 2.
3. On the command line, type **li** (line) and press **Enter**.

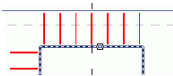
4. Click the lower lintel edge. 
5. Click inside the lintel to place the lower bar.

The bar is defined.

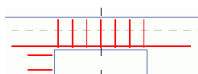

Repeat the process to place a bar in the window sill and another one on the side of the window.

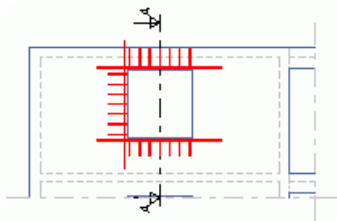

Example 5: Creating a free distribution

Next, a distribution is created based on the straight bars. Zoom in on the elevation on the lower bar of the window lintel.

1. On the **Reinforcement** toolbar, **Distributions** flyout, click .
2. Click the bar on the lower lintel side. A point bar is hooked on the cross center of the mouse cursor.

3. Create a distribution of two point bars around the rectangular frame from the lintel section.

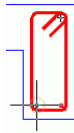

Note: To facilitate the placement of these two point bars, activate the snap point "center" on the AutoCAD® snap object.

Click the horizontal bar of the sill on the elevation.

Repeat the process to create the distribution inside the U bar of the window sill and a distribution inside the U bar on the left side of the window (top view).

Next, using symmetry, place the bars on the other side of the window. Zoom in so that the elevation and the top view are visible on the screen.

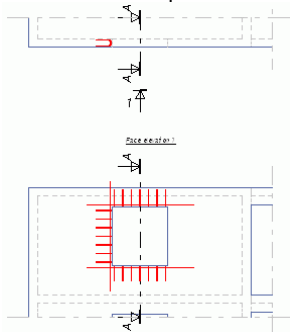

Mirror

To place the bars on the other side of the window, click the button on the AutoCAD® **Modify** toolbar.



1. Click **Mirror** (the AutoCAD® standard function).
2. Select the bars to copy:
On the top view: the U bar and the two point bars
On the elevation:
- The vertical bar on the left side of the window
- The distribution on the left side of the window
3. Press **Enter**.
4. Define the symmetry axis by clicking the middle of the lower window edge and the middle of the upper window edge.

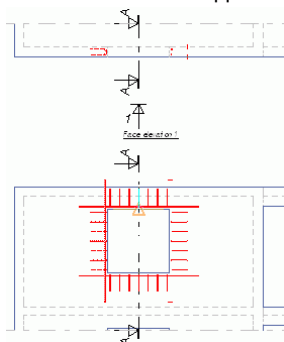

3D viewer

In Advance, although the reinforcement elements are drawn in 2D, they can be materialized in 3D with the 3D viewer.

Using the information from the 2D drawings, the viewer easily recreates the reinforcement cages. It works on bars, meshes and bent meshes. The 3D reinforcement cage can be stored as a drawing and printed.

The **Reinforcement 3D Viewer** toolbar contains tools for viewing the 3D reinforcement cages.



 **Example:** Viewing the reinforcement using the 3D viewer

1. On the **Reinforcement 3D viewer** toolbar, click .
2. Include the three views of the reinforcement drawing within a selection window and press **Enter**.

The wall reinforcement is displayed in 3D.

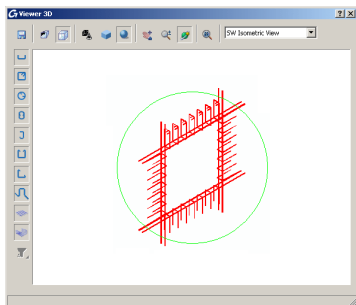

Placing the reinforcement symbols

Symbols are combinations of annotations and graphic elements. They contain a certain number of object attributes. They are updated as the objects are modified. Deleting the objects deletes the corresponding symbols.

The symbols are placed one by one on the reinforcement elements: bars, simple or bent meshes, and bars and bent meshes distributions.

 **Example:** Placing a bar symbol

This example shows the placing of a bar reference mark on the wall cut. Zoom in on the lintel section.

1. On the **Reinforcement symbols** toolbar, click .
 2. Click the rectangular frame and place the reference mark nearby.
- Repeat the process to place a reference mark on the two point bars.

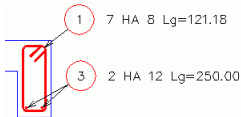

Repeat the process to place the reference marks for the sill reinforcement.

Distribution dimensions

Advance provides a command for creating dimensions on the linear or variable distributions.

 **Example:** *Dimensioning a linear distribution*

Zoom in on the window lintel elevation.

1. On the **Dimensions** toolbar, click .
2. Click the rectangular frame distribution.
3. Place the dimension line.
4. Click the position for the reference mark.

Repeat the process to place the dimensions for the four distributions of the window.

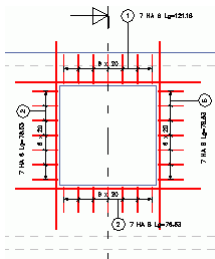

Lists

Advance provides a command for creating lists on layouts. Lists are created based on templates and are associated to structural element types (i.e., beams, columns, etc.) and to reinforcement element types (i.e., bars, meshes, etc.). Different list and schedule templates are available according to the international markets.

Custom list templates can also be created using the List generator.

The lists are automatically updated.







 **Example:** *Creating a bar list*

1. On the **Lists** toolbar, click .
2. On the command line, type **B** (Bars) to create a bar list.
3. Press **Enter**.

4. Include within a selection window the bars to list.
5. Press **Enter**.



6. The list is hooked to the mouse cursor.
7. On the **Smartbar**, select a template and a scale of **0.5**.
8. Place the list on the reinforcement drawing.

GRAITEC		BAR LIST (Metrics)		Tel: (+33) 963-13611 Fax: (+33) 963-6226 www.graitec.com info@graitec.com			
#	Quantity	Designation	Length (m)	Weight (kg)	Weight (kg)	Bar Shape	Min (mm)
1	7	1A	0.21	0.48	0.48		0.21
2	14	1A	0.79	0.33	0.33		0.21
3	4	1A	0.30	0.22	0.22		
4	8	1A	0.89	0.29	0.29		
5	7	1A	0.70	0.26	0.26		0.21
6	8	1A	0.65	0.24	0.24		
				Energy Equivalent	0.022		
					0.022		
				10	0.748		

This small exercise was a very simple introduction to Advance. With time, your familiarity, speed, and understanding of the power and versatility of Advance Concrete will improve as you use the software on real projects.

Canada**GRAITEC Inc.**

183, St. Charles St. W.
Suite 300
Longueuil (Québec) Canada
J4H1C8

Tel. (450) 674-0657

Fax (450) 674-0665

Hotline (450) 674-0657

Toll free 1-800-724-5678

Web <http://www.graitec.com/En/>

Email info.canada@graitec.com

Germany, Switzerland, Austria**GRAITEC GmbH**

Centroallee 263a
D-46047 Oberhausen Germany

Tel. +49-(0) 208 / 62188-0

Fax +49-(0) 208 / 62188-29

Web <http://www.graitec.com/Ge/>

Email info.germany@graitec.com

United Kingdom**GRAITEC UK Ltd.**

The Old Forge

Suth Road

Weybridge

Surrey KT13 9DZ

Tel. +44 (0)1932 858516

Fax +44 (0)1932 859099

Email sales@graitec.co.uk

Romania**GRAITEC Roumanie SRL**

Str. Samuil Vulcan, Nr. 10 Sector 5
București, Romania

Tel. +40 (21) 410 0119

Fax +40 (21) 410 0124

Mobile 0729 002 107

Web <http://www.graitec.com/Ro/>

Email sales@graitec.ro

France**GRAITEC France Sarl**

17 Burospace

91573 Bièvres Cedex

Tel. 33 (0)1 69 85 56 22

Fax 33 (0)1 69 85 33 70

Web <http://www.graitec.com/Fr/>

Email info.france@graitec.com

Czech Republic and Slovakia**AB Studio spol. s r.o.**

Jeremenkova 90a 140 00 PRAHA 4

Tel. +420/244 016 055

Fax +420/244 016 088

Hotline +420/244 016 050

Web <http://www.abstudio.cz/>

Email abstudio@abstudio.cz

United Kingdom**Adris Limited**

Riverside House, Brunel Road
Totton, Southampton, Hampshire
SO40 3WX England

Tel. +44 023 8086 8947

Fax +44 023 8086 1618

Hotline +44 023 8086 9995

Web <http://www.adris.co.uk/>

Email sales@adris.co.uk