



GRAITEC
G ADVANCE



STARTING GUIDE

G GRAITEC

www.graitec.com

TABLE OF CONTENTS

INTRODUCTION	5
Advance Steel	5
Where to find information?	6
Contacting technical support	6
INSTALLATION	7
System requirements	7
Hardware.....	7
Software	7
Starting the installation	7
STARTING ADVANCE	9
ADVANCE USER INTERFACE	9
Other important tools for using Advance	10
Advance UCS	10
Accessing Element Properties	11
3D MODELING	11
Advance objects	11
Creating a building grid.....	11
Creating beams	12
Straight beams	13
Curved beams	14
Plates.....	15
Splitting / merging – plates	16
Beam processing.....	16
Plate processing – element contour	17
Bolts, Holes, Shear Studs	18
Welds.....	19
Joints	20
Creating a frame.....	20
Accessing joint properties.....	21

Creating an eaves connection	21
Copying an eaves connection.....	22
Central rafter (ridge) connection	23
Creating a base plate.....	24
Copying an entire frame	25
Creating a bracing.....	26
Creating purlins.....	27
Creating a purlin support	28
Clash check	29
NUMBERING.....	29
DRAWING CREATION	30
Drawing management.....	32
Opening the Document Manager.....	32
CREATING LISTS.....	33

INTRODUCTION

This starting guide is a brief introduction to working with Advance Steel, describing the basic Advance methodology and not meant to replace formal training.

The **Advance Steel objects** chapter describes the main objects to create a small steel structure.

The examples presented in this guide are generic for worldwide use and do not conform to local or specific company standards.

Some of the Advance Steel connections are described in the **Joints** chapter and are used to create a small model. The 3D model is created using a 1:1 scale. The model contains information about dimensions, objects, and attributes from which drawings are created as described in the **Drawing Creation** chapter.

Since not all Advance tools are described in this guide, refer to the *online Help* for more details on all commands and parameters.

Advance Steel

Advance is a leading edge steel construction application integrated into the latest AutoCAD® version under the Windows operating system. It provides a simple user-friendly working environment for creating 3D structural models from which drawings are created.

The three dimensional model is created and stored in a drawing (in DWG format). The Advance model forms the basis of the 3D construction. Complex structures are created using Advance structural elements (e.g., a portal frame or a stairway) with all the required features, joints and connections, within a command.

The Advance model becomes the master reference for other tools:

- Dimensioned and labeled general arrangement and shop drawings are automatically created from the model.
- The Advance **Document Manager** manages all general arrangement and shop drawings. The update tool in the Document Manager makes single click drawing adjustments possible after model changes.
- Structured BOMs (bills of materials) and NC-information are also created from the model and include all model information such as part marks and quantities. The Document Manager also controls these documents.

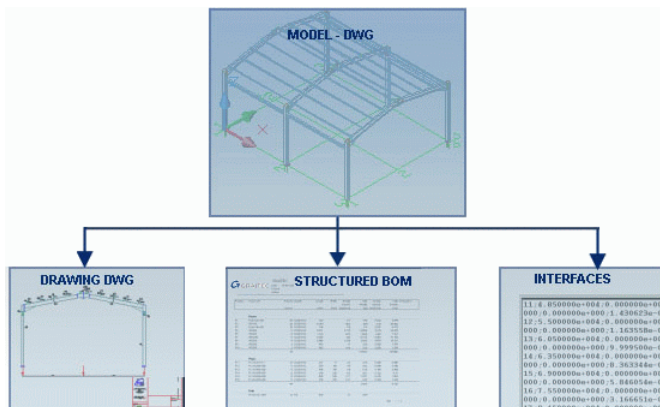

All software tools described in this guide and all remarks related to the product pertain only to the Advance Steel suite and for reading simplification only the generic name **Advance** is used.

Where to find information?

Advance has an online help system that offers step-by-step instructions for every function.

To access the help:

- Standard toolbar: click 
- Advance Steel menu: select Help > Online help
- Instant help: press F1

Contacting technical support

GRAITEC offers a technical support center for assistance in the daily use of the software. To reach technical support:

- Ask your dealer or closest GRAITEC office for the appropriate telephone number.
- Or write to: support.advance.sc@graitec.com

INSTALLATION

To successfully install Advance certain requirements have to be met.

System requirements

Hardware

- PC with Pentium Processor min. 2 GHz (4 GHz recommended)
- Main memory min. 2 GB
- AutoCAD® compatible graphics-card (for more information, see <http://www.autodesk.com/autocad-graphicscard>)
- Min. 1 GB free disk space on the hard disk
- Network adapter
- DVD Drive

Software

- Operating system Windows XP Professional or Windows Vista
- AutoCAD® 2007, ADT 2007, AutoCAD® 2008 or AutoCAD® Architecture 2008, AutoCAD® 2009 or AutoCAD® Architecture 2009, AutoCAD® 2010 or AutoCAD® Architecture 2010.
- TCP/IP Protocol
- The license is activated online.

Refer to the *online Help* for further information.

Starting the installation

Close all active Windows applications before starting the installation.

Proceed with the installation as follows:

1. Insert the installation DVD into the DVD drive.
 2. Start the installation by following one of these procedures:
 - On the Advance DVD – Browser, click **Setup**.
- or
- From Windows menu, select: **Start > Run**.
 - In the **Run** dialog box, click **Browse** to select the program *Setup.exe* on the DVD. Click **<OK>**.

The installation starts.

3. Select the language and click **<OK>** to continue.
4. Read the license agreement. Click **I accept ...** to agree to the specified terms and click **Next** to continue.
5. Select the type of installation and click **Next** to accept.
 - **Typical**: installs the most common application features. The software is installed on the Windows drive in **\Program files\Graitec\AdvanceSteel**.
 - **Custom**: installs only the selected application features.
 - **Complete**: installs all application features.
6. To have a custom installation, or to install Advance in a different folder, select **Custom**.

The components that can be installed are displayed.

*To check the available space on each hard drive, click **Disk Usage**.*

To change the destination path, click **Browse**. In the next dialog box, enter a path or select a different folder in which to install Advance and click **<OK>**, then **Next**.

7. Click **Install** to start the installation.

After installing Advance, a license is required to use the software. The license is activated based on the activation code and the serial number provided by the dealer. Once the license is successfully activated, the software can be used according to the license rights purchased.

Without the authorization code a temporary license for 5 days may be installed. When the temporary license expires, only AutoCAD® commands will be available.

The activation process starts on launching Advance. Follow the procedure described in the *Installation* chapter of the **User guide** to activate the product.

STARTING ADVANCE

To start AutoCAD® / Advance:

- Double click on the **Advance** Icon on the desktop.

or

- On the Windows task bar, click **Start**, then select

Programs > Graitec > Advance Steel and click the Advance icon to start the program.

ADVANCE USER INTERFACE

All Advance tools are grouped by type and are available on toolbars, positioned in a space saving manner in the AutoCAD® environment.

To keep the interface clear and commands easy to find, only two Advance toolbars appear when AutoCAD® / Advance starts.

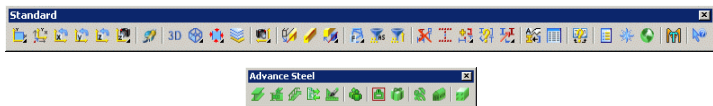

The main toolbars are accessed from the **Advance Steel** toolbar.

The main toolbars contain commands and buttons that open flyout toolbars. The flyout toolbar buttons are identified with a black triangle on the lower right corner. The flyout toolbars appear when the button is held down.

 **Example:** Accessing the **Sub – Axis grid flyout**.

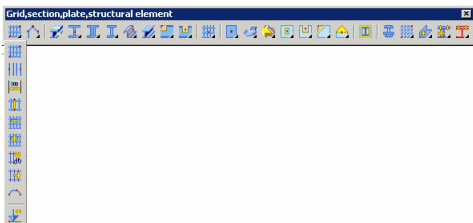

Main toolbars replace each other (with the exception of the **Design assistance** toolbar) so that the model workspace remains uncluttered.

Other important tools for using Advance



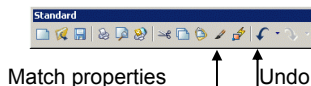

- To cancel a command in Advance, press the **Esc** key.
- The current command and prompts are displayed in the command line window at the bottom of the screen. Press the **F2** key to open and close the command line window.
- The right mouse click behaves like the **Enter** key.
- When the cursor hovers over a toolbar button, the button's tooltip appears.
- The **Undo** command on the AutoCAD® **Standard** toolbar cancels one or several commands.
- The **Match properties** command on the AutoCAD® **Standard** toolbar copies properties from one object to another. The transferred properties are selected from the given list.



Advance UCS

Advance objects are created in 3D-space using the appropriate tools and their orientation is dependent on the current User Coordinate System (UCS). To place the coordinate systems in the correct position use the buttons on the Advance **Standard** toolbar.



Button	Function
	Move the current UCS to a new origin point.
	UCS rotate around X
	UCS rotate around Y
	UCS rotate around Z

Accessing Element Properties

When creating an Advance element, a dialog box appears in which different settings (geometric sizes etc.) and drawing styles (e.g., dimension/label on the drawings) can be changed.

The settings in the dialog box are sorted on different tabs that vary with object type.

There are several ways to access the element properties:

- Click  on the Advance **Standard** toolbar.
- Right click and select **Advance Properties** from the context menu.

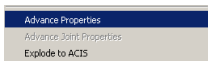

- Double click the element.

3D MODELING

Advance objects

Creating a building grid

The grid is useful for placing construction elements and for orientation in the 3D view. Placing grid axes is the first step of 3D modeling in Advance.

A building grid is created in the X/Y-plane of the current coordinate system and consists of two independent axis groups: in the X- and Y- directions.

The grid axis tools are grouped on the **Sub – Axis grid** flyout of the **Grid, section, plate, structural element** toolbar.



 **Example:** Building grid with 3 axes in the X-direction and in Y-direction

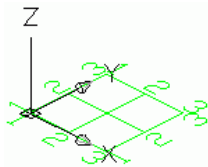

- On the **Grid, section, plate, structural element** toolbar, **Sub – Axis Grid** flyout, click

- Enter 0,0,0 on the command line to set the first point in the origin.
- Enter 5000, 5000 to set the second point.

Next, modify the axes number in each group.

- Select the X-axis group.
- On the **Standard** toolbar, click . The "Axes parallel" dialog box appears. All modifications are made here.

To modify the number of axes:

- Click the **Group** tab.
- Set the **Number** to 3. Note that the distance value is automatically calculated. The new value should be 2500.

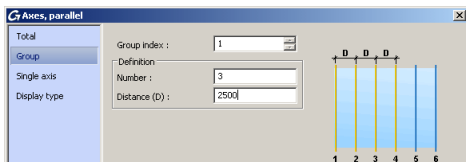

The model changes dynamically as values are entered or new values are selected, providing instant visual feedback.

Repeat the same steps for the axes in the Y-direction.

Creating beams

Beams are created directly in the model and are displayed, by default, in the 'wireframe' mode.

In Advance, a variety of different beam types are available.

The beam creation is performed using the five flyouts of the **Grid, section, plate, structural element** toolbar.



Beams are created as simple sections, compound sections, curved sections or welded sections.

The **compound** and **welded sections** are easy to use and save a lot of time.

Straight beams

Entering a starting point and an end point creates a straight beam in the Advance 3D model relative to the current user coordinate system (UCS).

The current user coordinate system (UCS) determines the position of the sections' main axes: the web of a beam runs in the Z-direction of the UCS (i.e., the 'top' of the section is in the Z-direction).

 **Example:** Creating straight beams HEA 200 x 2500 mm long

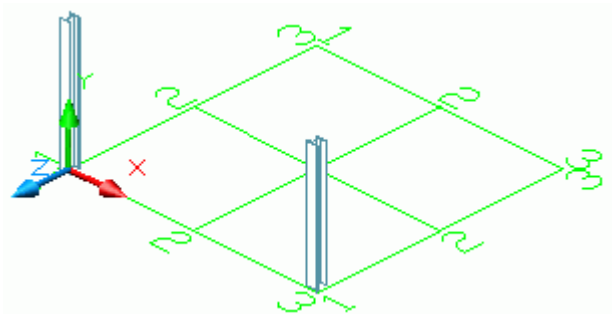

- Click a suitable UCS. Refer to the above figure for an example.
- On the **Grid, section, plate, structural element** toolbar, **Sub – Section classes** flyout, click .
- Select a starting point at (0,0,0).
- Move the mouse pointer upwards in the Y-direction (the setting ORTHO causes an exact orientation entry) and enter 2500.

The "Beam" dialog box appears. Select the section class (HEA), followed by the section (HEA 200).

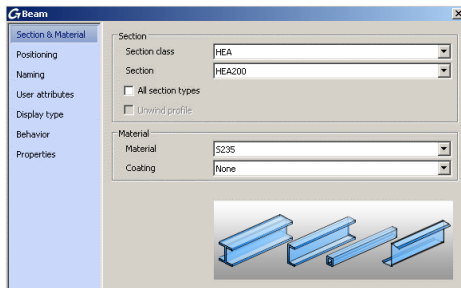

Curved beams

The current coordinate system determines the position of the main beam axes. The curved beam web runs in the Z-direction of the current UCS (i.e., the 'top' of the section is in the Z-direction). The created curved beam can be rotated 90° about its system line.

 **Example:** *Creating a curved beam between two columns*

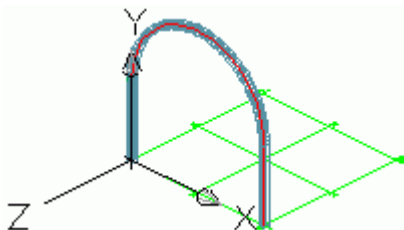

- Select a user coordinate system as shown in the figure above.
- On the **Grid, section, plate, structural element** toolbar, **Sub – Beams** flyout, click .
- Use the upper system line end points of the columns as the start point and end point.

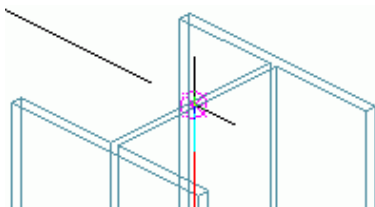

- Define the radius of the curved beam with a circle point.



The circle point must be defined in the X/Y-plane of the coordinate system.

Select a point at any radius and then specify the desired radius on the **Section & Material** tab in the dialog box.

Radius	2500
Tolerance	2.00

Plates

Plates are created in Advance in almost all shapes and sizes in any plane. The plates are placed in the X/Y-plane of the current coordinate system.

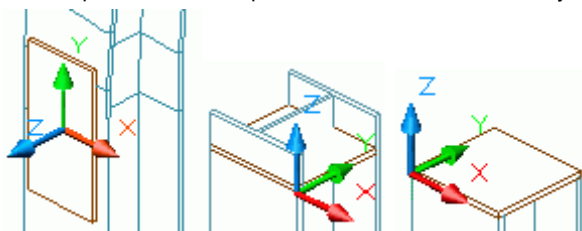



The tools to create plates are on the **Sub – Plate** flyout of the Advance **Grid, section, plate, structural element** toolbar.

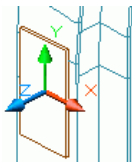

 **Example:** *Creating a rectangular plate using a center point*

- Place a coordinate system with the X/Y-plane in the desired plate plane. Select the middle point of the outer column flange.





- On the **Grid, section, plate, structural element** toolbar, **Sub – Plate** flyout, click .
- Set the plate center point by selecting the UCS origin or by entering the coordinates.
- The plate is created with a default length, width and height.
- Specify the size on the **Shape & Material** tab in the properties dialog box.

Width X	160.00
Length Y	300.00

Splitting / merging – plates

Existing Advance plates are divided into two or more plates using a polyline or two points. All plate features are maintained.

 **Example:** *Splitting a plate using two points*

- On the **Grid, section, plate, structural element** toolbar, **Sub – Plate** flyout, click .
- Set the first point by selecting the midpoint of the plate edge.
- Set the second point by selecting the midpoint of the opposite edge.

The plate is split.

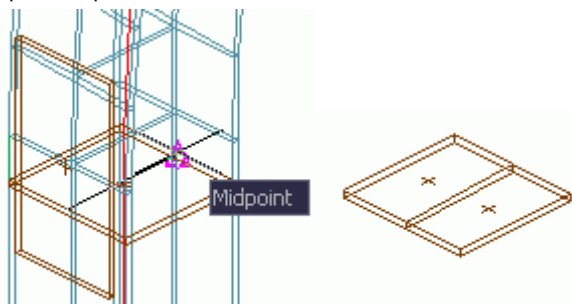

Beam processing

With the Advance beam processing almost any beam contour can be created. A beam can also be processed by another element (e.g., another beam).

The beam processings are located on two flyouts of the **Grid, section, plate, structural element** toolbar.



Processings are displayed as green contours in the model. These features are Advance Objects that cannot exist independently (i.e., they belong to a member).



*Processings are displayed only in the **Features** representation mode.*

 **Example: Creating a notch**

Given the following situation:

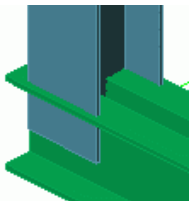

Column:

HEA 200

Compound section:

Double channel – back to back – U 220

- On the **Grid, section, plate, structural element** toolbar, **Sub – Process sections** flyout, click .
- Select the beam (in this example it is the column) to modify at the referenced end.

The notch is created and the properties dialog box appears. The beam can be modified to conform to specific requirements. For example, enter the notch width and depth on the **Shape** tab.

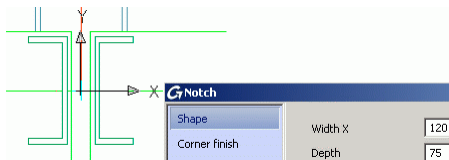







Plate processing – element contour

A plate is processed by a beam or by another plate with the **Element contour**  feature. There are two types of processings:

	Exact cross section
	Casing cross section

 **Example: Creating an exact casing cross section**

- On the **Grid, section, plate, structural element** toolbar, switch to .
- On the **Grid, section, plate, structural element** toolbar, **Sub – Plate** flyout, click .

- Select near a corner of the plate to modify.
- Next, identify the element that causes the modification; in this example it is the column.

The plate processing is created. Repeat the same steps for the other plate.

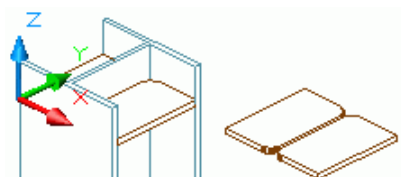



Bolts, Holes, Shear Studs

Bolt/hole patterns and shear studs can be created in any plane and are dependent on the current coordinate system.

Bolt patterns create connections between individual Advance objects (e.g., beam/plate or plate/plate).

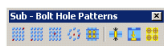
All three connection types, bolt patterns, hole patterns and shear studs are created with the same commands that are grouped on the **Sub – Bolt Hole Patterns** flyout.



 **Example:** Creating a rectangular bolt pattern using two diagonal points

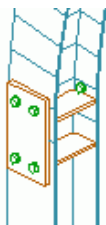

- Set a suitable user coordinate system.
- On the **Grid, section, plate, structural element** toolbar, select **Bolts** .

- On the **Grid, section, plate, structural element** toolbar, **Sub – Bolt hole patterns** flyout, click .
- Select the connected elements: the vertical plate and the column.
- Define a rectangular area using two diagonally opposite corner points.

The bolt pattern is created and the dialog box appears. The bolt pattern can be modified to conform to specific requirements.

Welds

Welds are created as weld points or weld lines. These objects contain the weld properties and the logical connection between connected structural parts.

Weld points are created as individual elements in the form of a cross whereas weld lines are represented in the model as thick polylines.



Example: *Creating a weld point*

- On the **Grid, section, plate, structural element** toolbar, **Sub – Weld patterns** flyout, click .
- Identify the connected objects (e.g., one column and the curved beam) and right click.
- Select the weld creation point and right click.

The weld point is created.

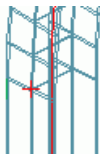

- On the **Grid, section, plate, structural element** toolbar, **Sub – Check connection** flyout, click  to display the connected elements. The connected elements are highlighted in red.

Joints

Another option for connecting members is using Advance joints. Joints are intelligent connections that consist of basic elements and dependent elements controlled by construction rules.

All individual joint elements, including their properties, are held together and represented as a gray box connection object.

A structural element creates several Advance objects at a time (i.e., entire structures are created by simply clicking one button).

All parts of a structural element are related to each other and their height, position, section, etc., are changed in one step.

Creating a frame

A frame is created with a few clicks using a structural element.

 **Example:** *Creating a symmetrical portal frame*

- Set a suitable user coordinate system.
- On the **Grid, section, plate, structural element** toolbar, **Sub – Structural elements** flyout, click .
- Define the first base point.
- Define the second point.
- Define the height of the frame with a right click.

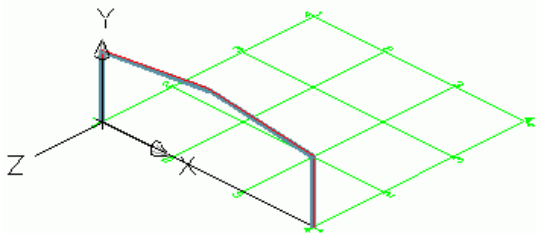

The frame is created and the properties dialog box appears. The frame size can be modified to suit specific requirements.

Accessing joint properties

To access the joint properties dialog box:

- Double click on the **connection object** (the gray box).
- or
- Select a joint element and right click.
 - Select **Advance Joint Properties** from the context menu.

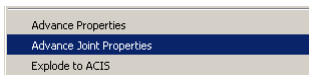

Creating an eaves connection

The knee frame joint connects the column and rafter elements.

The tools for eaves connections are grouped on the **Sub – Beam to column** flyout of the **Joints** toolbar.



 **Example:** *Creating a bolted knee frame connection with haunch*

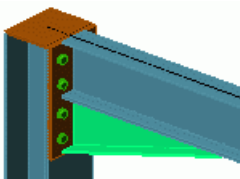

- On the **Joints** toolbar, **Sub – Beam to column** flyout, click .
- Select the column and right click.
- Select the rafter on which the knee of frame should be created and right click.

A message box appears, which states that no predefined joint for the selected sections has been found in the connection table.

- Click **<OK>**.

The joint is automatically created on the selected beams and can be modified in the dialog box.

Copying an eaves connection

The previously created joint is used as a template and copied with all its properties.

Select one knee of the frame element. The selected connection object is used as a template.

- On the **Joints** toolbar, **Sub – Joint utilities** flyout, click .
- Select the destination column and right click.
- Select the corresponding rafter.

When a joint is copied, all its properties and logic relations are copied and the values for the joint are only entered once.

Zoom/Shade

To better view the created connection, click the button **Zoom window** on the AutoCAD® **Zoom** flyout.



For a more realistic presentation of the model, click **Realistic visual style** on the AutoCAD® **Visual styles** toolbar.

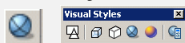

Cancel Shade/Zoom

To cancel the shading, click **2D Wireframe** on the AutoCAD® **Visual styles** toolbar.



To view the whole object, click **Zoom extents** on the AutoCAD® **Zoom** toolbar. The entire frame is displayed.





Central rafter (ridge) connection

In this example, an apex bolted with haunch is created at the frame summit.

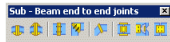
The joints for connecting beams by bolted end plates are grouped on the **Sub – Beam end to end** flyout of the **Joints** toolbar.



 **Example:** *Creating an apex bolted with haunch*

- Zoom in on the ridge point by entering two diagonal points of a window.
- On the **Joints** toolbar, **Sub – Beam end to end** flyout, click .
- Select the first rafter and right click.
- Select the second rafter and right click.
- Click **<OK>** in the "Attention" window.

The connection is created on the rafters of the frame and can be modified in the dialog box.

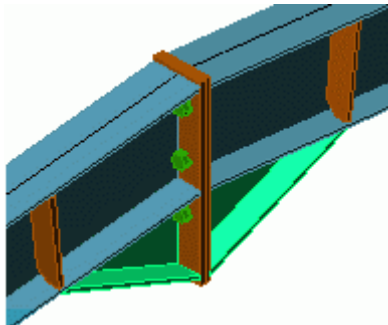

Creating a base plate

In this example, a base plate is created at the end of a column. The column is automatically shortened by the thickness of the base plate.

The tools for base plate connections are grouped on the **Sub – Base plate** flyout of the **Joints** toolbar.



 **Example:** Creating a base plate with shear section and stiffener

- On the **Joints** toolbar, **Sub – Base plate joints** flyout, click .
- Select the column and right click.
- Click <OK> in the "Attention" window.

The base plate is created at the end of the column and can be modified in the dialog box. Both the column and the plate are welded together.

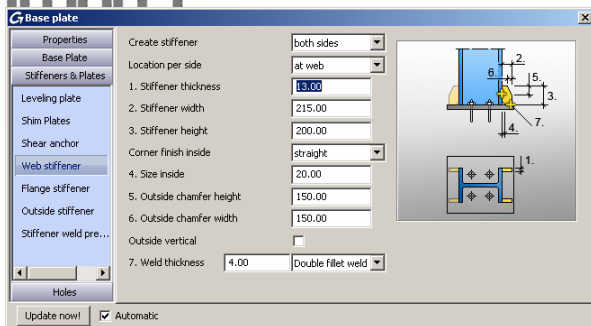
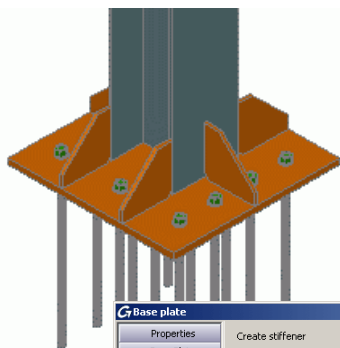

Copying an entire frame

Next, the frame is created and is copied with the standard AutoCAD® copy tool.

Get a complete view of the model

For a complete view of the model, click **Zoom extends** on the **Zoom** toolbar.



- Click **Copy object**  on the AutoCAD® **Modify** toolbar.
- Select the entire frame and right click.
- Select the base point of displacement.
- Select the target point of displacement.
- The frame is completely copied with all properties and connections using just two points. The only requirement is to construct one object and apply it at different positions.

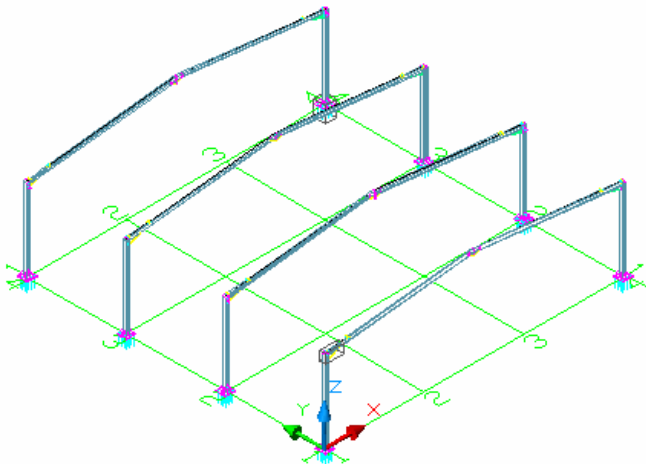

Creating a bracing

In this example, an angle bracing with plate is created.

The tools for connecting bracing members using gusset plates are grouped on the **Sub – General bracing joints** flyout of the **Joints** toolbar.



Example: Creating a bracing

- On the **Joints** toolbar, **Sub – General bracing joints** flyout, click .
- Select **two beams** to connect.
- Enter four points: the start and end points of the ascending and descending diagonal bracing lines. The starting points are at the bottom of the columns. Zoom in to make sure the correct points are selected using the snap **NODE**.

The bracing is created and can be modified in the dialog box.

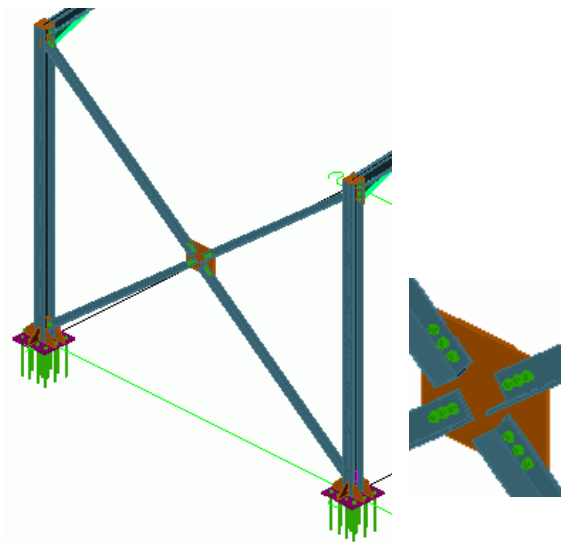

Creating purlins

The purlin tool creates a set of regularly spaced members on the selected rafters. Simply select the rafters and the purlins are automatically created. One option permits the selection of a column to position an optional eaves beam.

 **Example:** *Creating purlins on the selected rafters*

- On the **Grid, section, plate, structural element** toolbar, **Sub – Structural elements** flyout, click .
- Select the rafters and right click.
- To select a column for the eaves beam type 1 and press **Enter**.
- Select a column and right click.

The properties dialog box appears where the purlin layout can be modified.

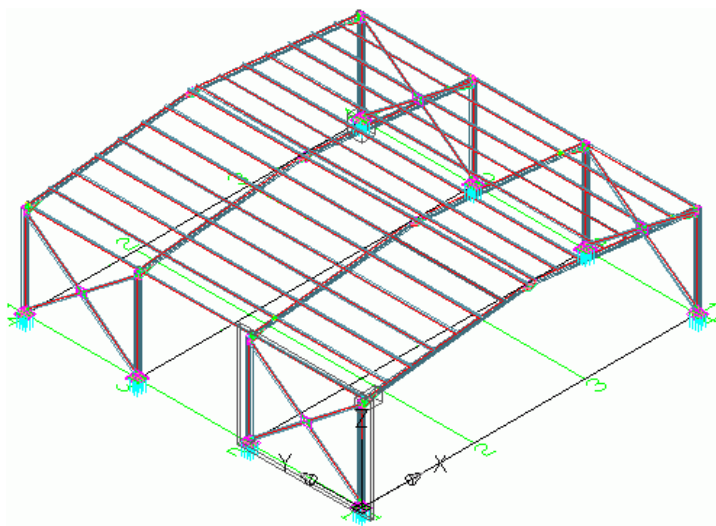

Creating a purlin support

Next, the purlin is connected to the rafter with specialized connections.

The tools for connecting purlins to rafters are grouped on the **Sub – Purlin joints** flyout of the **Joints** toolbar.

 **Example:** *Creating a purlin connection on the selected purlin and rafter*

- On the **Joints** toolbar, **Sub – Purlin joints** flyout, click .
- Select the rafter and right click.
- Select the outside purlin and right click.

The purlin connection is created and can be modified in the dialog box.



 **Example:** *Creating a purlin shoe for two purlins*

- On the **Joints** toolbar, **Sub – Purlin joints** flyout, click .
- Select the rafter and right click.
- Select the first purlin and right click.
- Select the second purlin and right click.

The purlin shoe is created and can be modified to conform to specific requirements.



Clash check

A clash check tests if there are model interferences. Object interferences might be due to various modifications made to plates, bolts, members and their connections. This tool finds all interference cases so that they are fixed in the model before drawing creation.

The Advance **Clash Check** function checks selected elements or the entire model. Interferences are displayed as red collision solids and listed in a text window.

 **Example:** *Checking the created frame for interferences*

- On the **Listing & checking** toolbar, **Sub – Checking** flyout, click "Clash check" .



- Press **F2** to open the text window.

The AutoCAD® text window appears and a list containing all collisions is displayed. If there are no collisions it will say, "no collision found".

- Exit the window.

NUMBERING

The Advance numbering tool **automatically** numbers Single Parts and Assemblies for the entire model. The numbering finds **identical parts** that should have the same number.

The numbering procedure is a single button function and works on the entire model or on selected elements.

With automatic numbering all beams and plates obtain a single part mark. All other elements are classified as attached parts. The numbering for single parts and assembly parts is done in one step or separately.



 **Example:** Both numberings in one step

- On the **Sub – Numbering** flyout, click .

The "Numbering" dialog box appears.

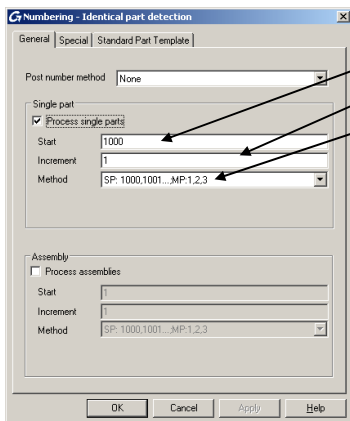

Define:

- The start value
- The increment value
- The numbering method

- Activate **Process assemblies** and **Process single parts**.
- For both, select method "SP: 1000,1001...;MP:1,2,3...".
- Press **F2** to obtain the results in the text window.

DRAWING CREATION

Tools for managing, creating and editing drawings are grouped on the Advance **Numbering drawing** toolbar.



The 2D drawings are obtained after the design and numbering of the 3D model.

Advance offers a variety of **drawing styles** for the creation of general arrangement drawings, sections, and shop drawings in various designs. A **drawing style** is a group of instructions used to create a detail drawing and defines the elements that are displayed including labeling and dimensioning preferences. The predefined drawing styles are different for each installation and country. Custom drawing styles are defined using the **Drawing Style Manager**. For more details, refer to the *Drawing Style Manager guide*.

 **Example:** Creating an isometric view

 Save the model prior to starting the drawing creation.

The viewport of the created view depends on the active user coordinate system (UCS). The view direction is against the Z-direction of the UCS.

- To create an isometric view, click  on the AutoCAD® **UCS** toolbar and place the UCS in the plane of the screen.

- On the **Sub – Drawing view** flyout, click .

The "Drawing type" dialog box appears. Change the scale to 1:50.

- Click **<OK>** to close the dialog box.

The "Select destination file" dialog box appears.

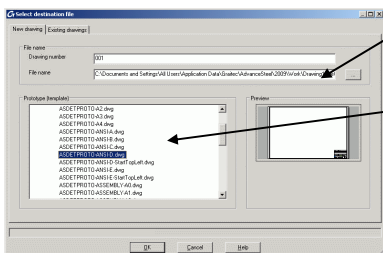

Set a path for a separate DWG in which the detail is placed.

Select the prototype template: ASDETPROTO-ANSI-D.dwg.

- Click **<OK>**.

The drawing is created and saved as .dwg in the specified path.

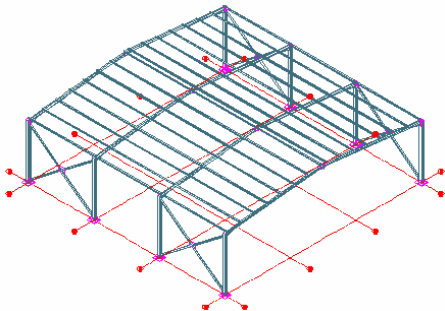

Drawing management

The **Document Manager** is used to preview, manage and erase the created details in separate drawings (DWGs).

The link between the model and the drawing is managed automatically. Advance automatically detects the details that require updating due to model modifications. The **Document Manager** also controls drawing updates.

The **Document Manager** controls all dependent details and lists all information (e.g., which model drawings have been created and how many). More than one detail can be stored in a single DWG. The **Document Manager** tree structure shows the details that are in each DWG.

Opening the Document Manager

- On the **Numbering**, drawing toolbar, **Sub – Drawing management** flyout, click .

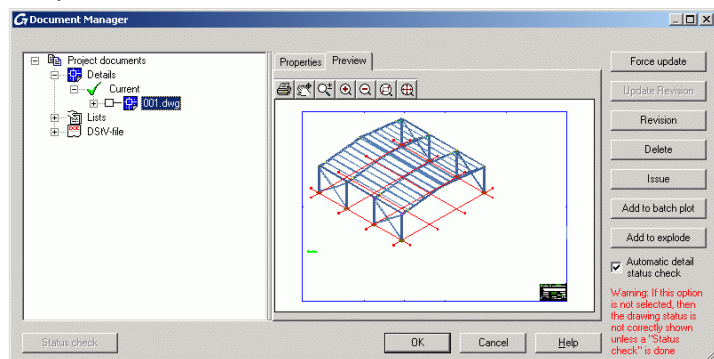

The **Document Manager** lists all created drawings, bill of materials / structured BOMs and the NC-data created from the model. The documents are displayed on the **Preview** tab.

CREATING LISTS

In Advance, lists are created in several different formats.

All model objects including their graphic and non-graphic properties, features and connections are stored and managed by Advance.

A list is created in two steps:

- Create extracts from the numbered and saved models.
- Create structured BOMs from the extracts using the Advance List Template Wizard.

The created BOMs can be saved, printed or exported in several formats.

Example: *Creating a model extract containing the beams in the model*

- On the **Listing & checking** toolbar, **Sub – BOM** flyout, click

A window appears where the model objects for the extract can be selected.

Different saved configurations of model objects

Select the model objects for the current configuration.

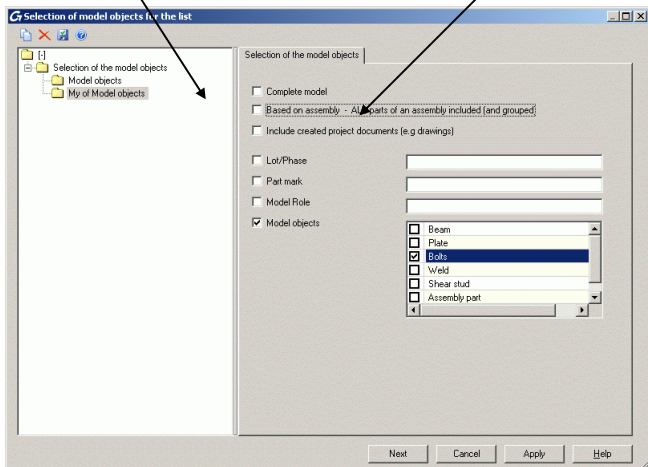

- Check **Model objects** and then select **Beams** to select all the beams.

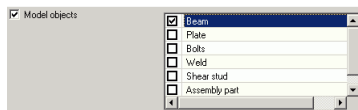

- Click **New**  on the dialog box toolbar to save a selection set.
- Select a model object from the list in the dialog box. Enter a name and click **Next**.

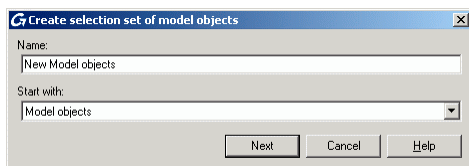

The name is displayed in the left field.

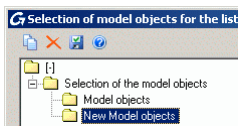

- Click **Apply** to save the configuration. Click **Next** to continue.
- In the "Select destination file" dialog box, click **<OK>** to save the file.

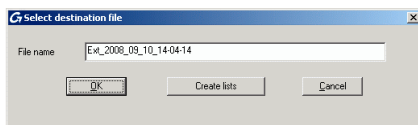

If **Create list** is clicked, the information is stored and the List Template Wizard opens automatically to create and print the lists.

Example: Creating a BOM based on a previously created model extract

- On the **Listing & checking** toolbar, **Sub – BOM** flyout, click to start the Advance List Template Wizard.

An Advance template may be selected or users can define their own templates starting from an existing one.

- Select a BOM template.
- Click **Use**.

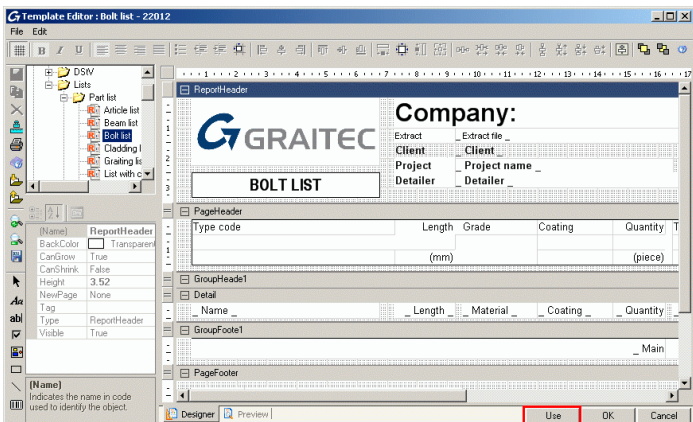

A dialog box appears. Select the desired model extract.

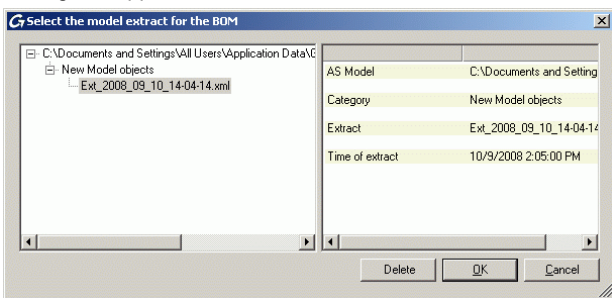

- Click **<OK>** to finish the BOM creation.

The structured BOM appears. It can be printed, saved, exported to PDF (and other formats) or sent by e-mail using the corresponding icons on the menu bar.

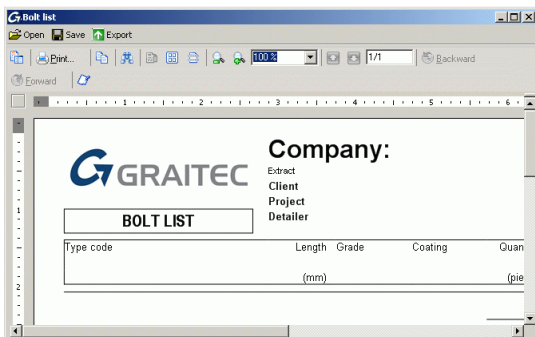

- Click **Export**. The "Report export" dialog appears displaying the export options.

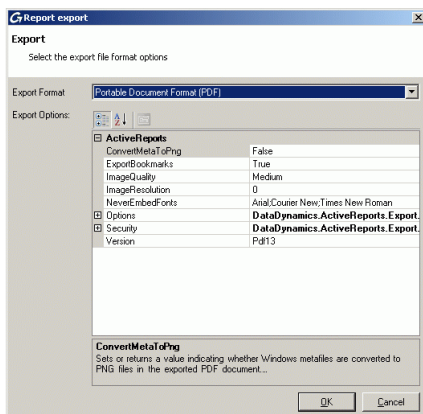

- Select an export format from the list.
- Click **<OK>**.

- Save the created BOM file. A file name is requested in a new window. The BOM file is saved as a Report in the folder
...[model folder]\[model name]\BOM\[BOMfilename]

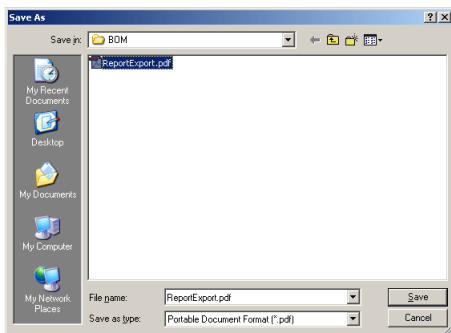

This small exercise was a very simple introduction to Advance Steel. With time, your familiarity, speed, and understanding of the power and versatility of Advance Steel will improve as you use the software on real projects.

Canada**GRAITEC Inc.**

183, St. Charles St. W.
Suite 300
Longueuil (Québec) Canada
J4H1C8

Tel. (450) 674-0657
Fax (450) 674-0665
Hotline (450) 674-0657
Toll free 1-800-724-5678
Web <http://www.graitec.com/En/>
Email info.canada@graitec.com

Germany, Switzerland, Austria**GRAITEC GmbH**

Centroallee 263a
D-46047 Oberhausen Germany

Tel. +49-(0) 208 / 62188-0
Fax +49-(0) 208 / 62188-29
Web <http://www.graitec.com/Ge/>
Email info.germany@graitec.com

United Kingdom**GRAITEC UK Ltd.**

The Old Forge
Suth Road
Weybridge
Surrey KT13 9DZ

Tel. +44 (0)1932 858516
Fax +44 (0)1932 859099
Email sales@graitec.co.uk

Romania**GRAITEC Roumanie SRL**

Str. Samuil Vulcan, Nr. 10 Sector 5
București, Romania

Tel. +40 (21) 410 0119
Fax +40 (21) 410 0124
Mobile 0729 002 107
Web <http://www.graitec.com/Ro/>
Email info.romania@graitec.com

France**GRAITEC France Sarl**

17 Burospace
91573 Bièvres Cedex

Tel. 33 (0)1 69 85 56 22
Fax 33 (0)1 69 85 33 70
Web <http://www.graitec.com/Fr/>
Email info.france@graitec.com

Czech Republic and Slovakia**AB Studio spol. s r.o.**

Jeremenkova 90a 140 00 PRAHA 4

Tel. +420/244 016 055
Fax +420/244 016 088
Hotline +420/244 016 050
Web <http://www.abstudio.cz/>
Email abstudio@abstudio.cz

Russia**GRAITEC CJSC**

Locomotivny Proezd 21, Build. 5,
Office 503

Moscow 127238 - Russia

Tel. +7(495) 225-13-65
Fax. +7(495) 488-67-81
Email info.russia@graitec.com